

4 Tn.

MODELO	REF.			H. min.		
C - 440	13.340	4.000 Kg.	840 Kg.	130 mm.	400/230 v. · 3 Kw.	35"
C - 441	13.341	4.000 Kg.	950 Kg.	170 mm.	400/230 v. · 3 Kw.	35"
C - 442	13.342	4.000 Kg.	1.000 Kg.	170 mm.	400/230 v. · 3 Kw.	35"

TURISMOS + PEQUEÑOS FURGONES pasarela de 4.335 m/m.

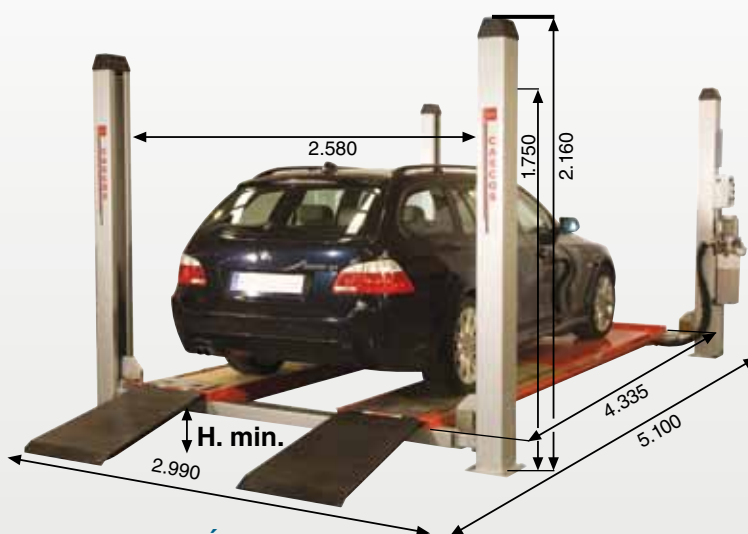
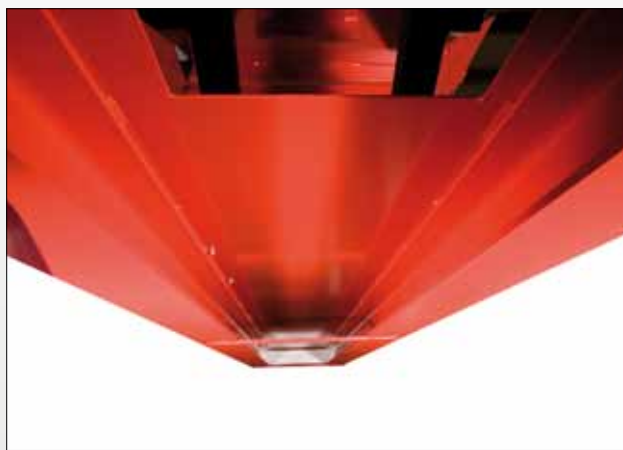

PASARELAS EXTRA REFORZADAS

Vigas **doble T** refuerzan nuestras pasarelas, garantizando su perfecta **nivelación con el paso del tiempo**.

ALTURA MÍNIMA

La **más baja** del mercado, permitiendo trabajar con **rampas más cortas** para vehículos deportivos y de perfil bajo. C440, h min: 130mm C441/442, h min 170mm



ALERTAS

Un **testigo** previene, en caso de incorrecta nivelación de las pasarelas, lo cual permite al cilindro trabajar en **buenas condiciones** y **alargar su vida útil**.

SEGURIDAD x2

Cascos **prioriza** ante todo **la seguridad** incluyendo de serie **doble sistema de seguridad**, **mecánica** (barra de seguridad) y **neumática** (cremallera).

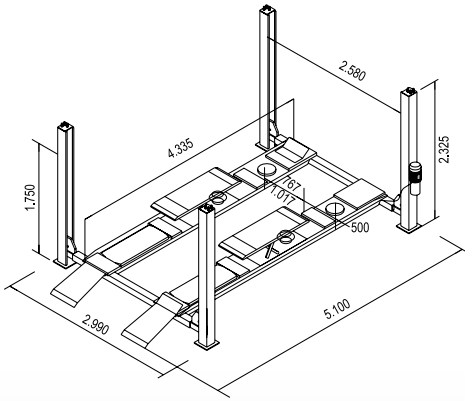

- 1 C - 440
REF.: 13.340
- 2 C - 441
REF.: 13.341
- 3 C - 442
REF.: 13.342

- 1 Pasarela lisa.
- 2 Pasarela lisa con encastre delantero, preparada para opción de platos de alinear traseros.
- 3 Pasarela de Alineación, con encastre delantero y platos de alinear traseros.

GATOS NEUMÁTICOS

	TV 1500	TV 3000	DSTV 1500	DSTV 3000	DSTV 3000 AUDI
REF.	60.150 N.	60.300	70.155	75.300	75.314
	1.500	3.000	1.500	3.000	3.000



TV 1.500



TV 3.000



DSTV 1.500

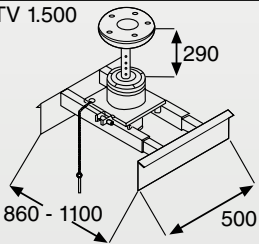

TV 1.500

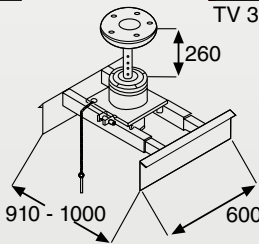

TV 3.000

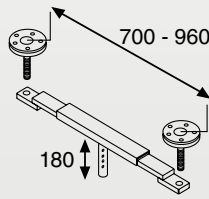

TV 1.500

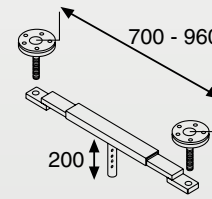

TV 3.000

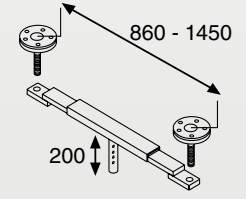

TV 3.000

GATOS OLEONEUMÁTICOS

780 - 1610 (mod. 2 tns)/780 - 1180 (mod. 2,6 tns.)

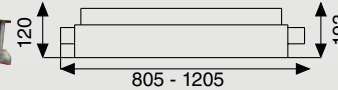
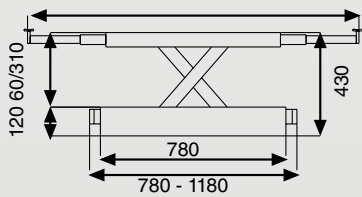

PASARELA SIN PESTAÑA

2 Tn.	50515
2,6 Tn.	50517

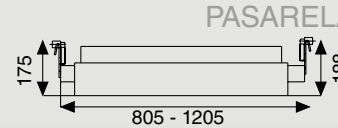

PASARELA CON PESTAÑA

2 Tn.	50514
2,6 Tn.	50516

OPCIONAL



KIT DE ILUMINACIÓN 24 v. Ref. 34051



KIT DE ENERGÍA Ref. 26150

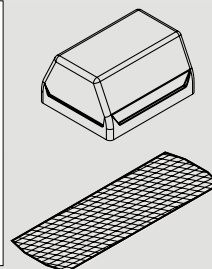

CAPERUZA	REF.
C - 440/41/42/43/44/45/50/55	32.129

PLATOS MÓVILES	REF.
C - 432	29.700
C - 442	33.700



CASCOS MAQUINARIA, S.A

Zurrupitieta, 8 - Pol. Ind. Jándiz • Apartado 264
01015 VITORIA-GASTEIZ España - Spain

Tel. +34 945 290 294 - Fax +34 945 290 055
e-mail: cascos@cascos.es • www.cascos.es

CASCOS MAQUINARIA SE RESERVA EL DERECHO DE REALIZAR MODIFICACIONES TECNICAS SIN PREVIO AVISO

